

Static Routing Exercise



Scalable Infrastructure
Workshop
AfNOG 2011

What will the exercise involve?

- Unix network interface configuration
- Cisco network interface configuration
- Static routes
- Default route
- Testing

Routing

- ❑ Routing is done based on destination IP address
- ❑ Without routing, an interface can only reach destinations that are on their local network segment.
- ❑ A device with at least 2 interfaces can route

Routing

- Static route
 - specifically instructs router on which route to take to a particular destination network. This will almost always override anything else that the router knows.
- Dynamic route
 - learnt via routing protocols implemented on routers
- Default route
 - route that instructs a machine where to send packets for destinations that are not in the routing table. This is usually the 'last resort' that a router will take.

Static Routing

□ Advantages

- Simple to configure and maintain
- Secure as only defined routes can be accessed
- Bandwidth is not used for sending routing updates

□ Disadvantages

- Manual update of routes after changes
- Explicit addition of routes for all networks
- Potential for configuration mistakes

IP Routing Configuration

Static/default route example

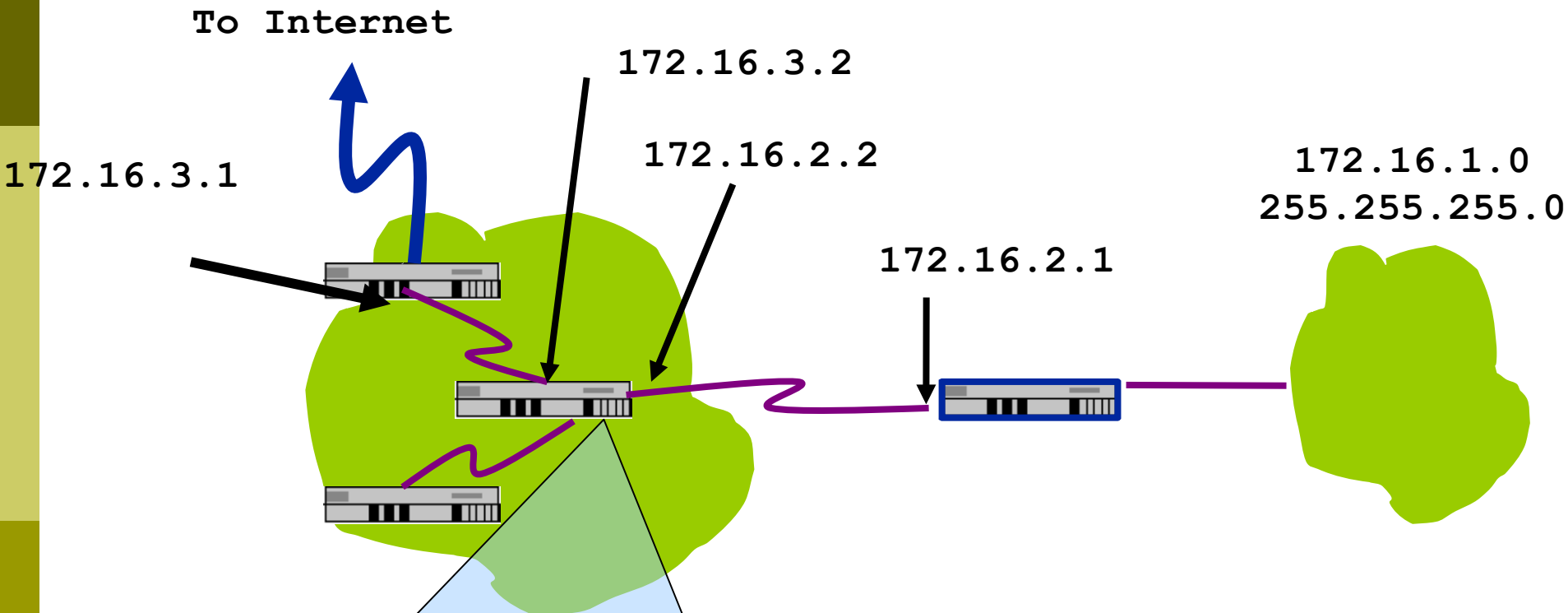

```
ip route 172.16.1.0 255.255.255.0 172.16.2.1 # STATIC
ip route 0.0.0.0 0.0.0.0 172.16.3.1 # DEFAULT
```

Classroom Network Layout

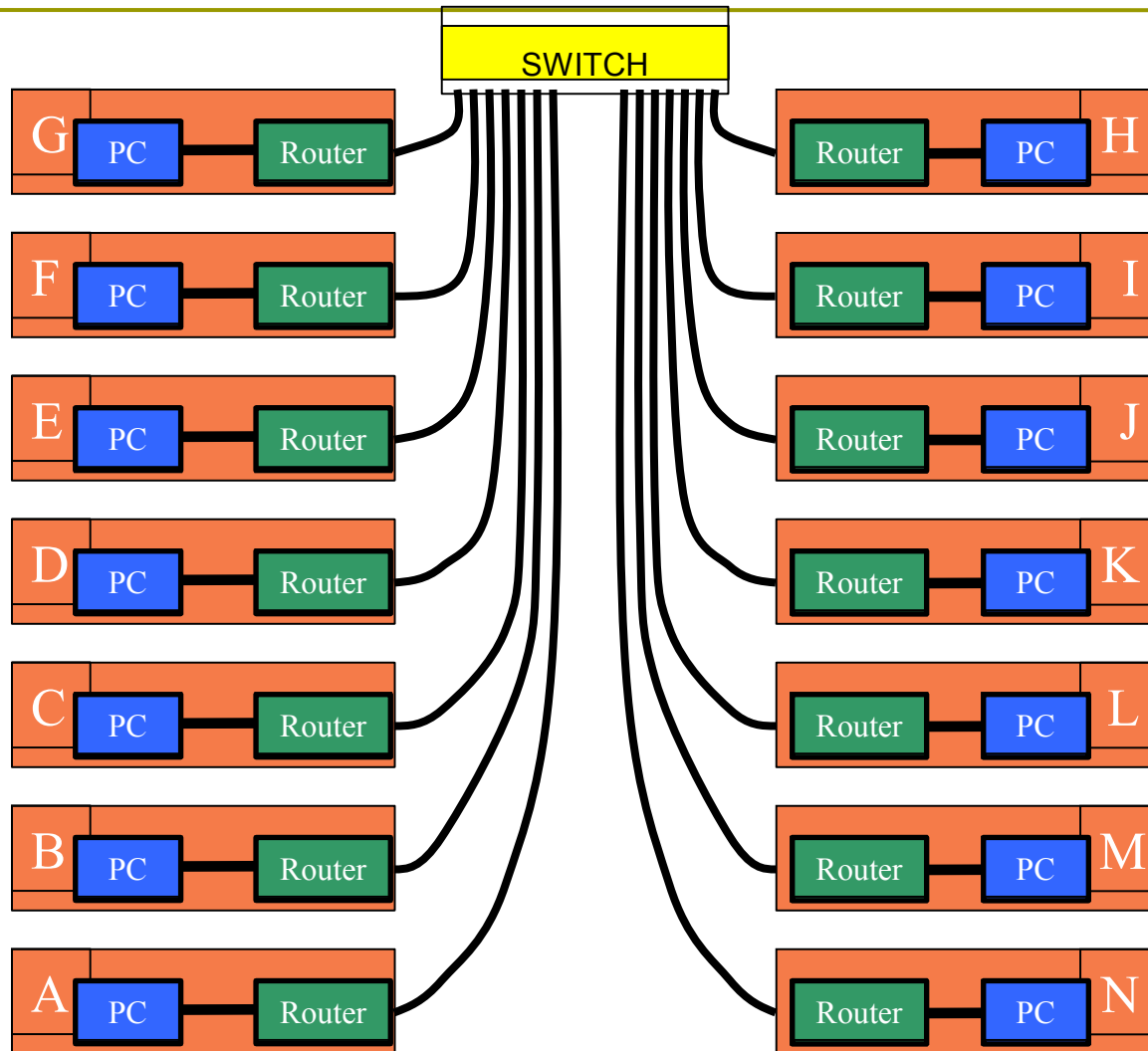

Exercise One



IPv4 Address Assignments

SWITCH

N
196.200.220.240/28

M
196.200.220.224/28

L
196.200.220.208/28

K
196.200.220.192/28

J
196.200.220.176/28

I
196.200.220.160/28

H
196.200.220.144/28

.1
14

.13 .2

.12 .3

.11 .4

.10 .5

.9 .6

.8 .7

196.200.220.0/27

A
196.200.220.32/28

B
196.200.220.48/28

C
196.200.220.64/28

D
196.200.220.80/28

E
196.200.220.96/28

F
196.200.220.112/28

G
196.200.220.128/28

IPv4 Address Assignment

- ❑ You already have an IP address for your router's backbone link (A=.1, B=.2, ...)
- ❑ You have a /28 for your local network (PC and router connected back to back)
- ❑ Assign your own host addresses from your /28 to your local network.

FreeBSD Network Interface Configuration

- configure interface on Unix host
 - `ifconfig em0 inet n.n.n.n netmask m.m.m.m`
- (you need to be root to change the IP address)
- `em0` is the interface name
 - `n.n.n.n` is IP address
 - `m.m.m.m` is netmask

Connect PC to router console port

- ❑ Connect cable to console port on router, serial port on FreeBSD box
- ❑ Use the `tip` command to connect your keyboard and screen to the serial port
 - e.g. `bash$ tip com1`
- ❑ You may have to edit `/etc/remote`
- ❑ See man pages for `tip(1)` and `remote(5)`
 - HINT: to exit `tip`, type `~`.

Cisco Router Network Interface Configuration

- configure backbone interface on cisco router

```
conf t
```

```
interface fastethernet0/0
```

```
ip address n.n.n.n m.m.m.m
```

fastethernet0/0 is interface name

n.n.n.n is IP address

m.m.m.m is netmask

- Now configure the local interface on your router that connects to your PC (ie. Fa0/1). Use the IP address assignments that you made 3 slides ago.

Cisco Router Network Interface Configuration

- ❑ Cisco global config should always include:
`ip classless`
`ip subnet-zero`
`ip cef`

- ❑ Cisco interface config should usually include:
`no shutdown`
`no ip proxy-arp`
`no ip redirects`
`no ip directed-broadcast`

Forwarding Tables at this point in the exercise

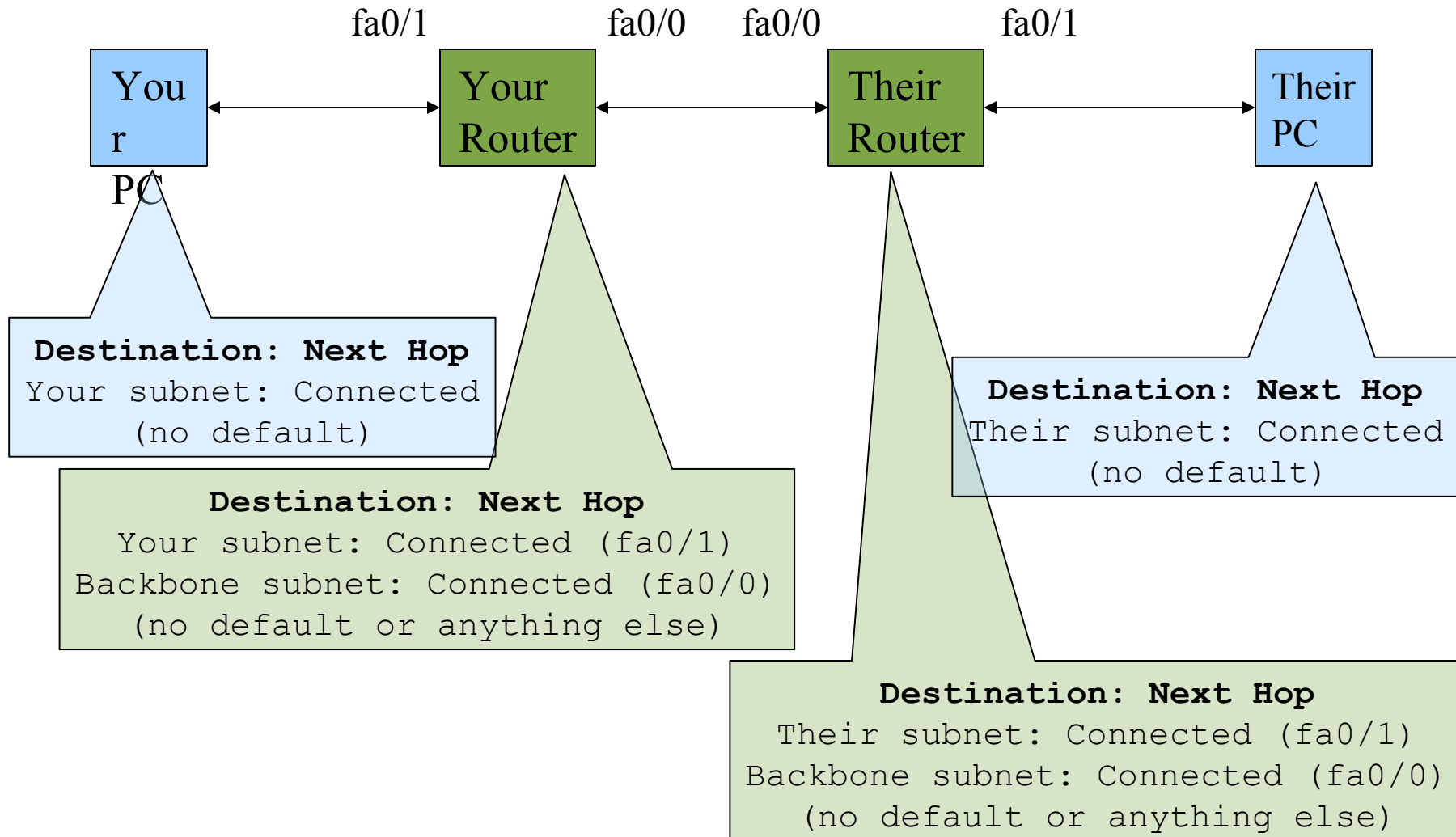

Test Connectivity

- ❑ PC can ping local interface of router
- ❑ Router can ping PC
- ❑ Router can ping other routers

- ❑ PC cannot ping backbone interface of router
- ❑ PC cannot ping other routers or other PCs
- ❑ Router cannot ping other PCs.

Configure a default route

- Add route on PC

```
route add default g.g.g.g
```

g.g.g.g is the IP address of your gateway, which will be the IP address of your router's interface to your subnet. (Don't use your router's backbone IP address.)

- Display forwarding table

```
netstat -rn
```

Forwarding Tables at this point in the exercise

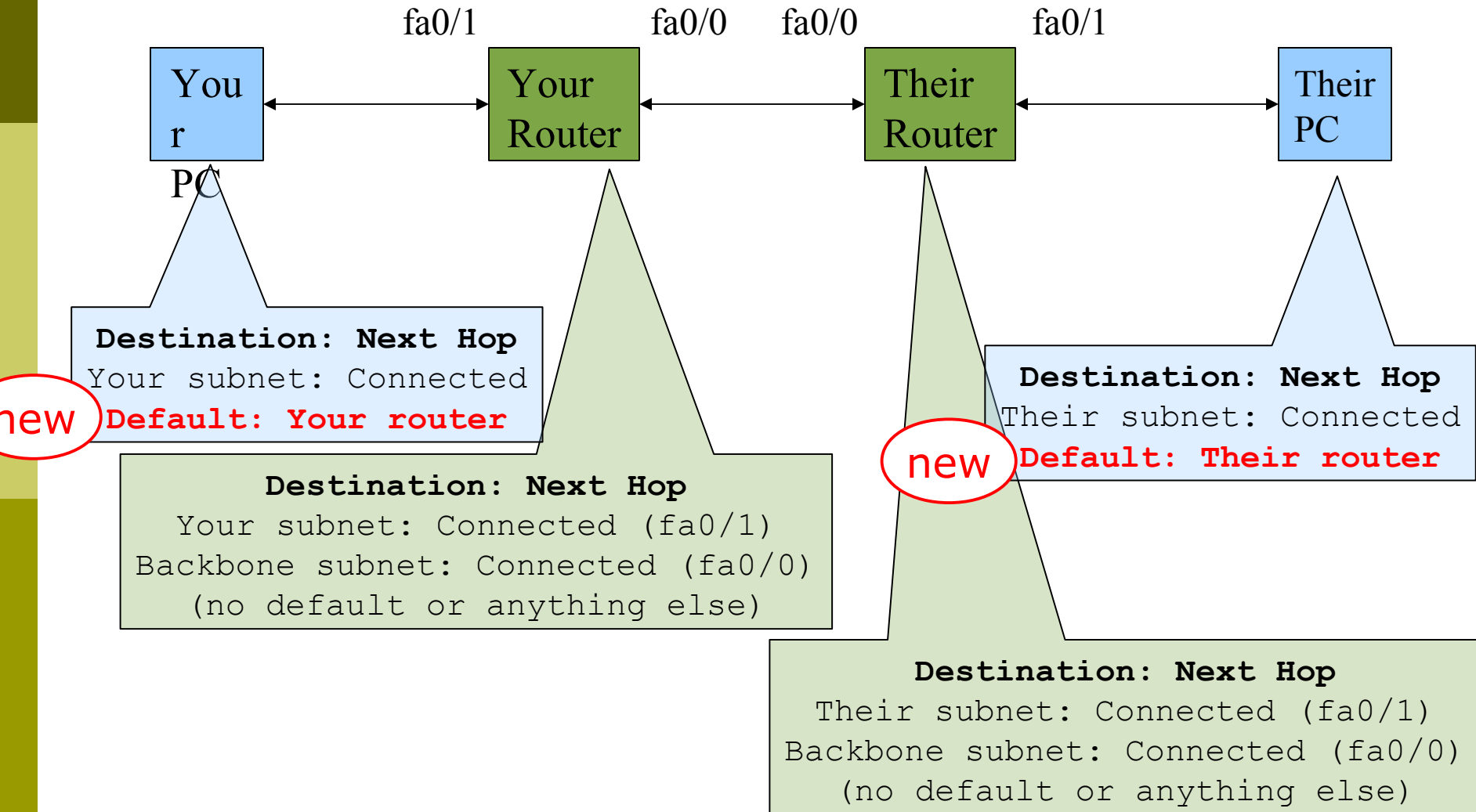

Test connectivity

- All PCs should now be able to reach the backbone IP address of their own routers.
- But, you still can't reach other PCs, or other routers.
 - why?

When you ping their router...

PING

src = Your PC

dst = Their Router (backbone address)

REPLY

src = Their Router (backbone address)

dst = Your PC

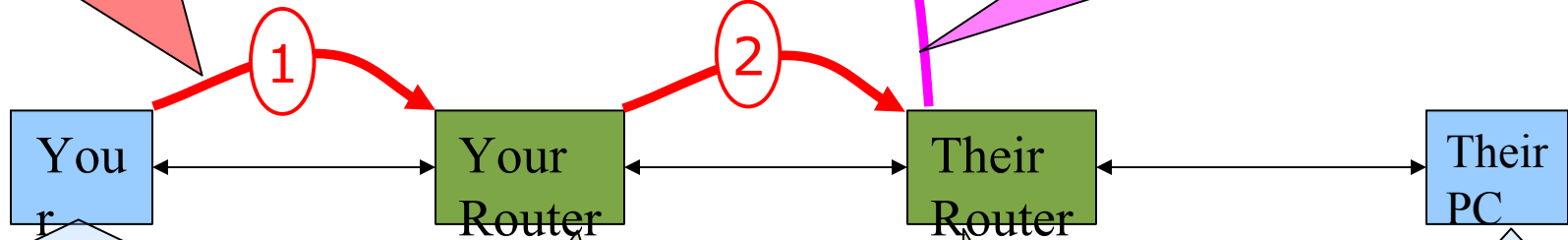

Destination: Next Hop

Your subnet: Connected

1 Default: Your router

Destination: Next Hop

Your subnet: Connected (fa0/1)

2 Backbone subnet: Connected (fa0/0)

(no default or anything else)

Destination: Next Hop

Their subnet: Connected

Default: Their router

Destination: Next Hop

Their subnet: Connected (fa0/1)

Backbone subnet: Connected (fa0/0)

(no default or anything else)

3 ???

Configure static routes for the remaining classroom desks

- ❑ On your router, add static routes to the other PCs, using their router's backbone IP addresses as the next-hop.

```
ip route n.n.n.n m.m.m.m g.g.g.g
```

n.n.n.n m.m.m.m is their subnet and netmask

g.g.g.g is their router's address on the backbone

- ❑ Do this for every PC/router cluster in the class
 - **There are A LOT of them.** Cut and paste?
- ❑ Consult the map earlier to obtain the PC/router local subnet, and the corresponding router backbone IP address.

Forwarding Tables at this point in the exercise

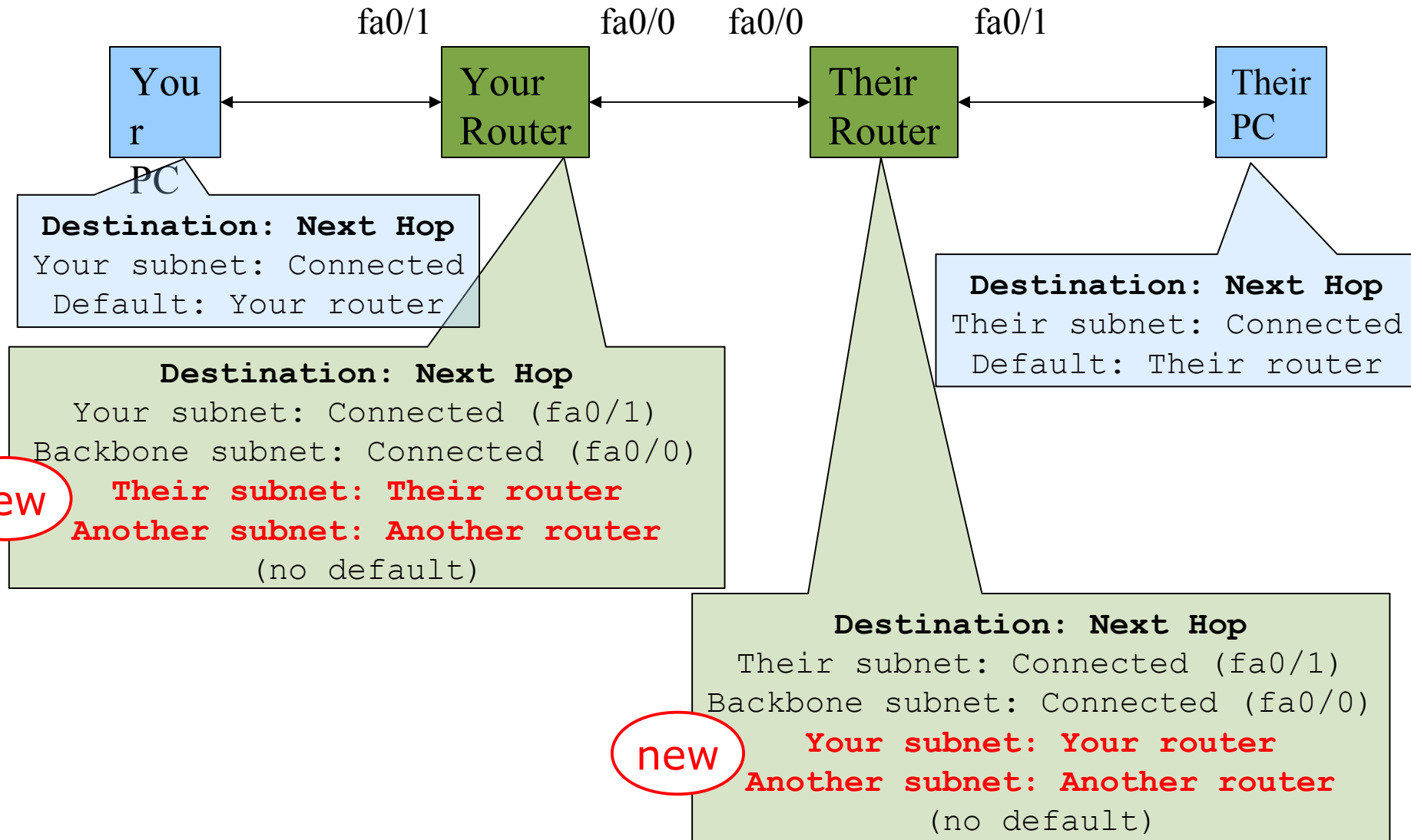

Test Connectivity

- ❑ All routers can reach all PCs
- ❑ All PCs can reach all backbone IP addresses
- ❑ All PCs can reach PCs in other rows
- ❑ Test with traceroute

When your PC pings their PC...

PING

src = Your PC

dst = Their PC

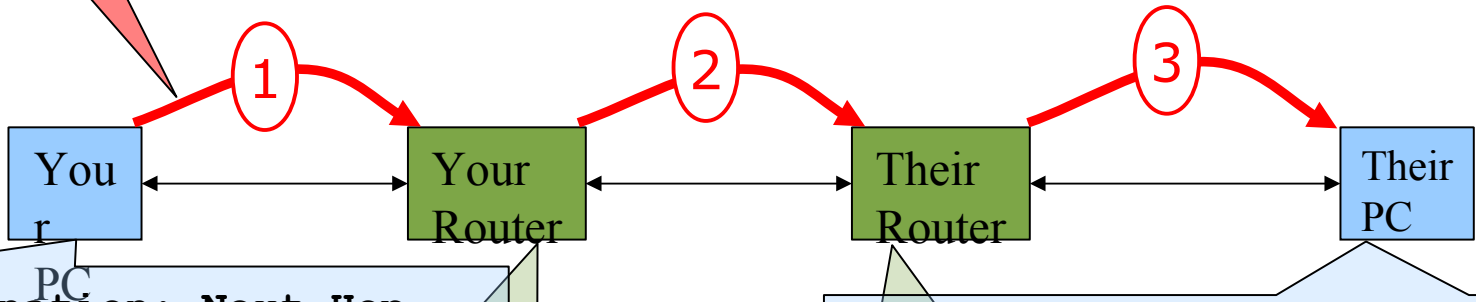

Destination: Next Hop

Your subnet: Connected

1 Default: Your router

Destination: Next Hop

Your subnet: Connected (fa0/1)

Backbone subnet: Connected (fa0/0)

2 Their subnet: Their router

Another subnet: Another router
(no default)

Destination: Next Hop

Their subnet: Connected

Default: Their router

Destination: Next Hop

3 Their subnet: Connected (fa0/1)

Backbone subnet: Connected (fa0/0)

Your subnet: Your router

Another subnet: Another router
(no default)

... and the reply from their PC

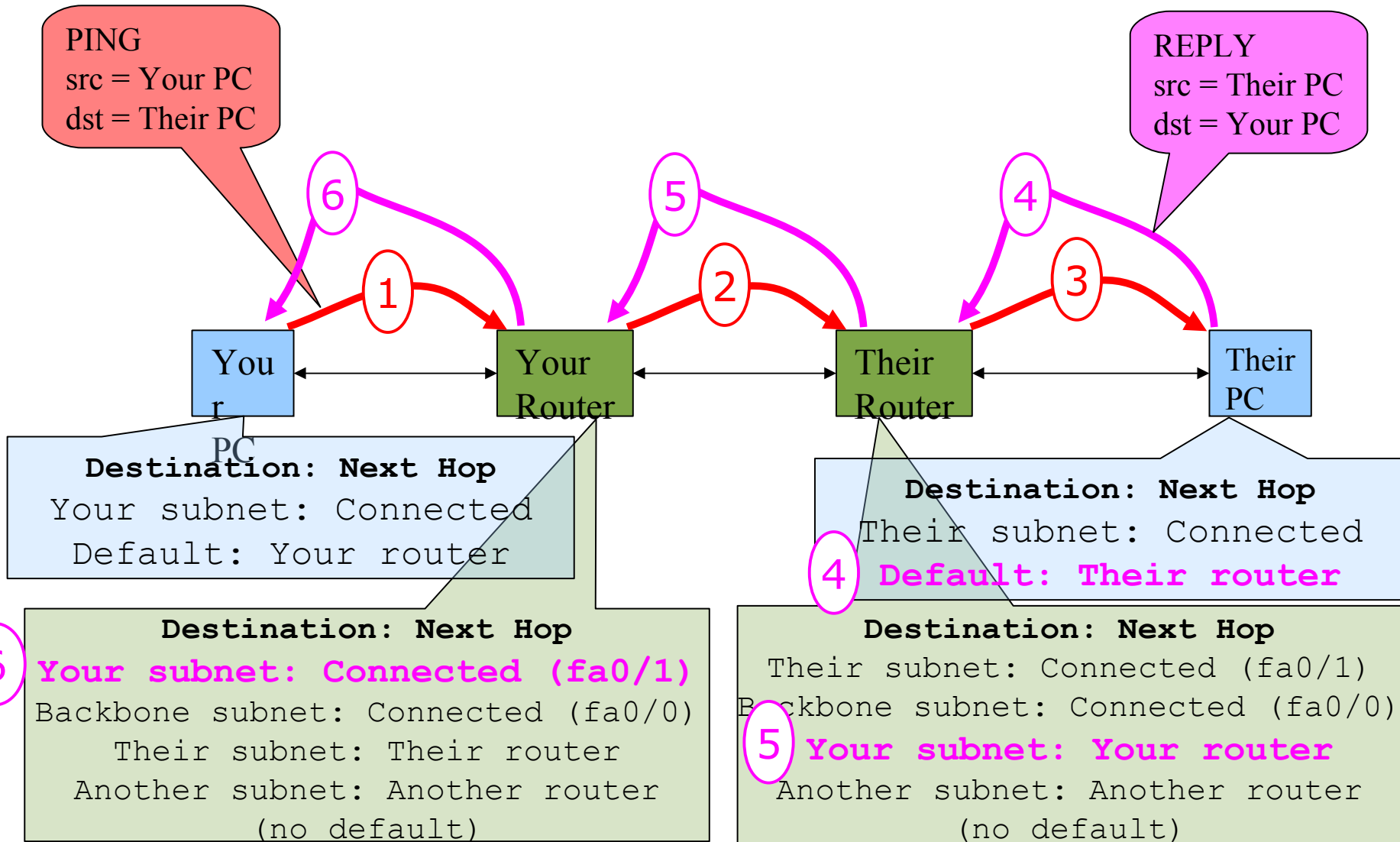

Static Exercise using IPv6

- ❑ Now let's repeat this exercise using IPv6 addressing
- ❑ Consult addressing plan for IPv6 addresses
 - Link between router and PC gets a /60
 - ❑ Group A use 2001:43f8:220:10::/60
 - ❑ Group B use 2001:43f8:220:20::/60
 - ❑ etc
 - Backbone is numbered from 2001:43f8:220:0::/64
 - Group A use 2001:43f8:220:0::1/64
 - Group A use 2001:43f8:220:0::2/64

Big Hint!

- ❑ If you are not using COPY/PASTE or the TFTP method to upload your config, you are wasting a lot of your time!

IPV6 Address Assignments

SWITCH

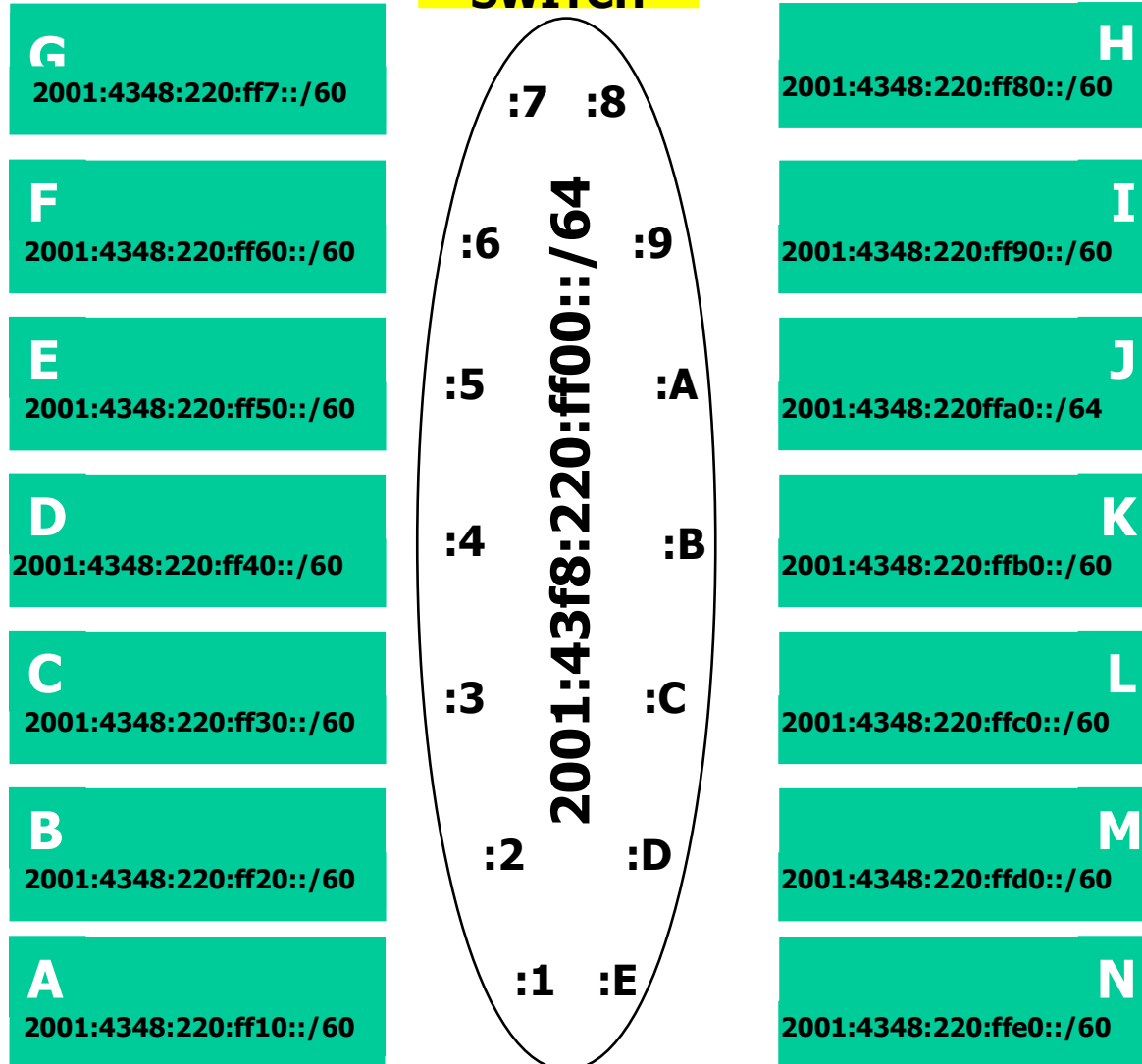

FreeBSD Network Interface Configuration

□ configure interface on Unix host
`ifconfig em0 inet6 n:n:n:n/m`

em0 is interface name

n:n:n:n is IPv6 address

m is netmask

Cisco Router Network Interface Configuration

- ❑ Configure the backbone interface on your router

```
conf t
```

```
ipv6 unicast-routing
```

```
interface fastethernet0/0
```

```
  ipv6 address n:n:n:n/m
```

fastethernet0/0 is interface name

n:n:n:n is IPv6 address

m is netmask

- ❑ Now configure local (lan-facing) interface on your router too.

Cisco Router Network Interface Configuration

- Cisco ipv6 global config should always include:

no ipv6 source-route

ipv6 cef

- Cisco interface config should additionally include:

no ipv6 redirects

Configure a default route

- Add route on PC

```
route add -inet6 default g:g:g:g
```

- g:g:g:g is IPv6 address of gateway (which is on Cisco router)
- -inet6 tells FreeBSD that this is an IPv6 route

- Display forwarding table

```
netstat -rn
```

Configure static routes for the remaining classroom desks

- On your router, add static routes to the other clusters, similar to how you did for ipv4.
 - next hop is backbone interface of other row's router

```
ipv6 route n:n:n:n/m g:g:g:g
```

- Repeat several times until complete

Test Connectivity

- All routers can reach all PCs
- All PCs can reach all backbone IP addresses
- All PCs can reach PCs in other rows
- Test with traceroute

Exercise Two



IPv4 Address Assignments

E2 Router
196.200.220.30/27

SWITCH

G
196.200.220.128/28

F
196.200.220.112/28

E
196.200.220.96/28

D
196.200.220.80/28

C
196.200.220.64/28

B
196.200.220.48/28

A
196.200.220.32/28

.7 .8

.6 .9

.5 .10

.4 .11

.3 .12

.2 .13

.1 .14

196.200.220.0/27

H
196.200.220.144/28

I
196.200.220.160/28

J
196.200.220.176/28

K
196.200.220.192/28

L
196.200.220.208/28

M
196.200.220.224/28

N
196.200.220.240/28

IPv6 Address Assignments

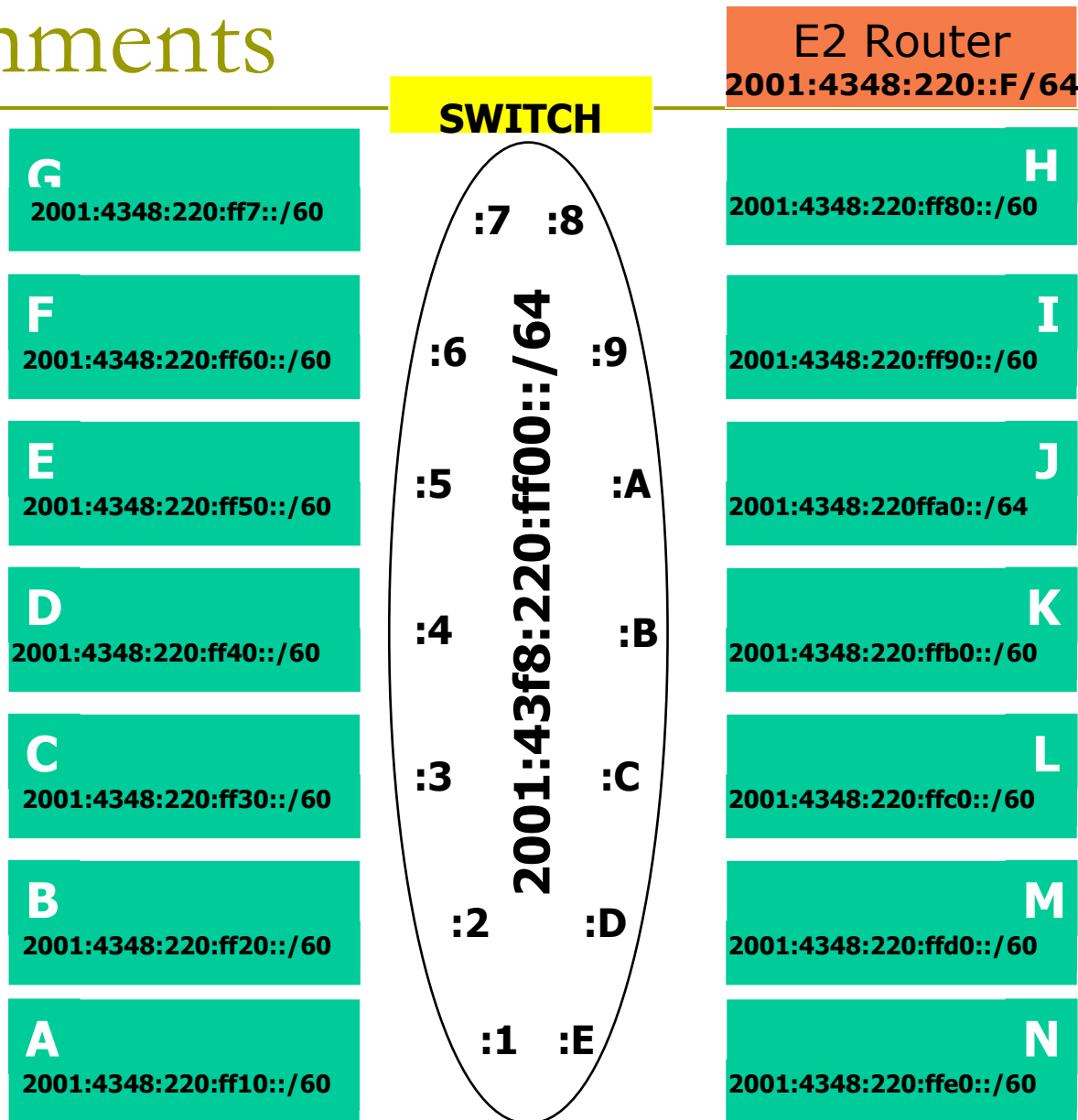

Configure static routes to classroom router

- ❑ On your router, remove all static routes

```
no ip route n.n.n.n m.m.m.m g.g.g.g
```

- ❑ Repeat until complete

- ❑ Add a default route point to the SIE classroom router

- (next hop is backbone IP address of the SIE router)

```
ip route 0.0.0.0 0.0.0.0 g.g.g.g
```

- ❑ Do the same for IPv6:

```
no ipv6 route n:n:n:n/m g:g:g:g
```

```
ipv6 route ::/0 g:g:g:g
```

Test Connectivity

- All routers can reach all PCs
- All PCs can reach all backbone IP addresses
- All PCs can reach PCs in other rows
- Test with traceroute
 - Test both IPv4 & Ipv6

- How is this working?
 - All static routes have been added to the classroom router.

Edit FreeBSD's `/etc/rc.conf` file

- ❑ On production machines, add lines to `/etc/rc.conf` to preserve network settings on reboot

```
hostname="porcupine.tomato.example"  
ifconfig_em0="inet X.X.X.X netmask Y.Y.Y.Y"  
ipv6_ifconfig_em0="X:X:X:X prefixlen 64"  
defaultrouter="G.G.G.G"  
ipv6_defaultrouter="G:G:G:G"
```

- ❑ See `/etc/default/rc.conf` for more information

Static Routing Exercise



The End